

DIBUJOS TÉCNICOS · TECHNICAL DRAWINGS

REF. 640-PB50

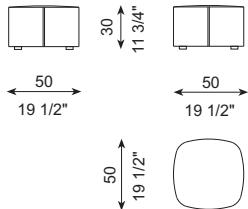

REF. 640-P50

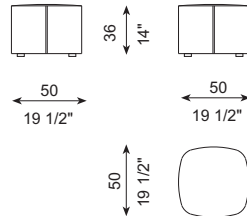

REF. 629-PB70

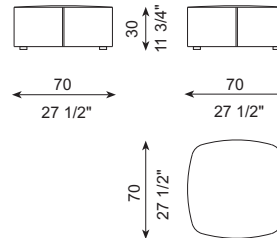

REF. 629-P70

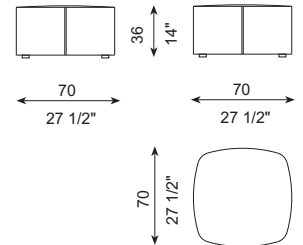

REF. 640-P100

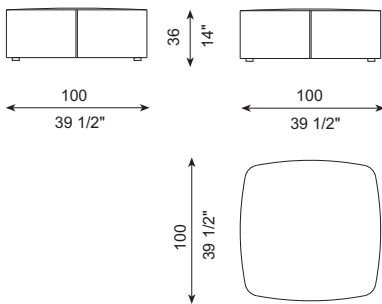

REF. 640-P120

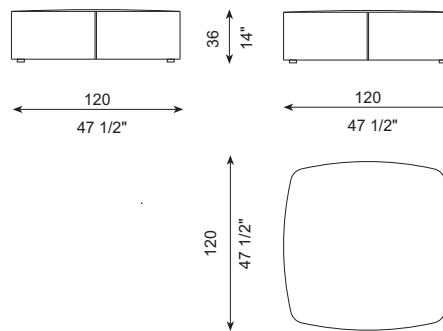

ESPECIFICACIONES · SPECIFICATIONS

Pufs realizados en estructura de madera recubierta de espuma de poliuretano de diversas densidades y capa de fibra de poliéster. Tapizado fijo, no desfundable. Patas en polipropileno.

Structure in wood, covered with polyurethane foam with different densities and layer of polyester fiber. Fixed cover, not removable. Feet in polypropylene.

Gestell aus Holz, bezogen mit verdichtetem Polyurethanschaum und Polyesterfaserauflage. Fest angebrachter Bezug, nicht abnehmbar. Füße aus Polypropylen.

Structure en bois, recouverte de mousse de polyuréthane avec différents densités et couche de fibre de polyester. Housse fixe, non amovible. Pieds en polypropylène.